

OPERATOR'S MANUAL
MODEL TD INFERNO HD
KOHLER KDI 2504
FLAMELESS DIESEL FIRED HEATER



THERMDYNAMICS, MFG. INC
27077 S. Gayle Ave
TEA, SOUTH DAKOTA 57064
WWW.THERMDYNAMICS.COM

PHONE: 605-498-1050
FAX: 605-498-1051
REV 12-20-25

Le manuel français est disponible par la demande. S'il vous plaît nous contacter directement à
605.498.1050 demander un manuel.

TABLE OF CONTENTS

OPERATORS MANUAL

Introduction	3
Safety Warning	4
Heater Identification	5-10
Preparing for Operation	11
Starting Procedures	12
Warm up – Throttle Interlock	13
Shut Down Procedures	13
Cold Weather Starting	13
Remote Temperature Control	14
Maintenance Instructions	15
Towing Instructions	15-16
Lifting Instructions	17
Specifications	17
Automatic Shut-down System	18
Lubricants	18
Filter Part Numbers	19
GPS Connection	20
Trouble Shooting Guide	21
Tire Safety	22-32
Reporting Safety Defects	33

ADDITIONAL MANUALS

Control Panel User Guide
Heater Maintenance Program
TD Limited Warranty

INTRODUCTION

This manual provides the information necessary for the safe operation and maintenance of the Therm Dynamics Heater.

Specific operating details and specifications are contained in this publication to familiarize the operator and maintenance person with the correct and safe procedures necessary to maintain and operate this equipment.

Take time to read this book thoroughly. If you are uncertain about any of the information contained in this manual, contact your dealer for clarification before operation of the machine.



The purpose of the SAFETY INFORMATION SYMBOL shown above is to attract your special attention to safety-related information contained in the text.

FAILURE TO UNDERSTAND AND COMPLY WITH SAFETY RELATED INFORMATION AND INSTRUCTIONS MAY RESULT IN INJURY TO THE OPERATOR OR OTHERS. IF YOU DO NOT UNDERSTAND ANY PART OF THIS INFORMATION CONTACT YOUR DEALER FOR CLARIFICATION PRIOR TO OPERATING EQUIPMENT.

NOTE:

The word "NOTE " is used to bring your attention to supplementary information in relation to various aspects of proper operation and maintenance.

NOTE: Keep this manual accessible during operation to provide convenient reference.

NOTE: Any reference in this manual to LEFT or RIGHT shall be determined by looking at the heater from the REAR.



SAFETY WARNING!

- NEVER ALLOW ANYONE TO OPERATE THE EQUIPMENT WITHOUT PROPER TRAINING
- THE INSTALLATION OF THE UNIT SHALL BE IN ACCORDANCE WITH THE REGULATIONS OF THE AUTHORITIES HAVING JURISDICTION AND CSA STANDARD B139
- DURING OPERATION; COMBUSTIBLE MATERIALS MUST BE KEPT A MINIMUM OF TWO FEET AWAY FROM ALL SIDES OF THE HEATER, HEATER MUST BE ON A NONCOMBUSTIBLE FLOOR. IF HEATER IS EQUIPPED WITH TUBE STORAGE, COMBUSTIBLE MATERIAL CANNOT BE STORED IN THIS AREA.
- DO NOT OPERATE UNIT IN CLOSE QUARTERS OR PARTLY VENTILATED AREA WITHOUT VENTING THE EXHAUST TO THE OUTSIDE OF STRUCTURE
- DO NOT FILL FUEL TANK WHILE UNIT IS OPERATING
- DO NOT USE GASOLINE, CRANKCASE OIL OR HEAVIER THAN #2 DIESEL FUEL
- EXHAUST STACK, ENGINE, AND HEAT PLATE ASSEMBLY MAY BECOME DANGEROUSLY HOT. DO NOT TOUCH DURING OR IMMEDIATELY AFTER OPERATION
- SHOCK OR INJURY MAY RESULT FROM WORKING ON ELECTRICAL COMPONENTS. DISCONNECT BATTERY BEFORE PERFORMING ANY REPAIRS
- SERIOUS INJURY MAY RESULT FROM CONTACT WITH ROTATING PARTS. STAND FREE OF MOVING PARTS AND POSSIBLE PINCH POINTS PRIOR TO START-UP AND DURING OPERATION
- WEAR APPROVED EAR PROTECTION EQUIPMENT WITHIN 10 FEET (3.05 METERS) OF OPERATING HEATER. FAILURE TO DO SO MAY RESULT IN IMPAIRMENT OR LOSS OF HEARING
- DO NOT SMOKE OR USE AN OPEN FLAME IN HEATER VICINITY WHILE SERVICING THE FUEL TANK. FAILURE TO COMPLY MAY RESULT IN SERIOUS INJURY OR DEATH
- ALWAYS READ THE INSTRUCTIONS FIRST.

Right Side View



1. T-Handle Door Latch
2. Fork Pocket
3. D-Ring
4. Break Away Brake System
5. Pressure Chamber and Heat Plate Filter Access
6. Engine Exhaust Stack
7. Skyhook
8. Emergency Stop
9. Outlet Baffle Adjustment
10. Fuel Tank
11. Duct Storage

Left Side View

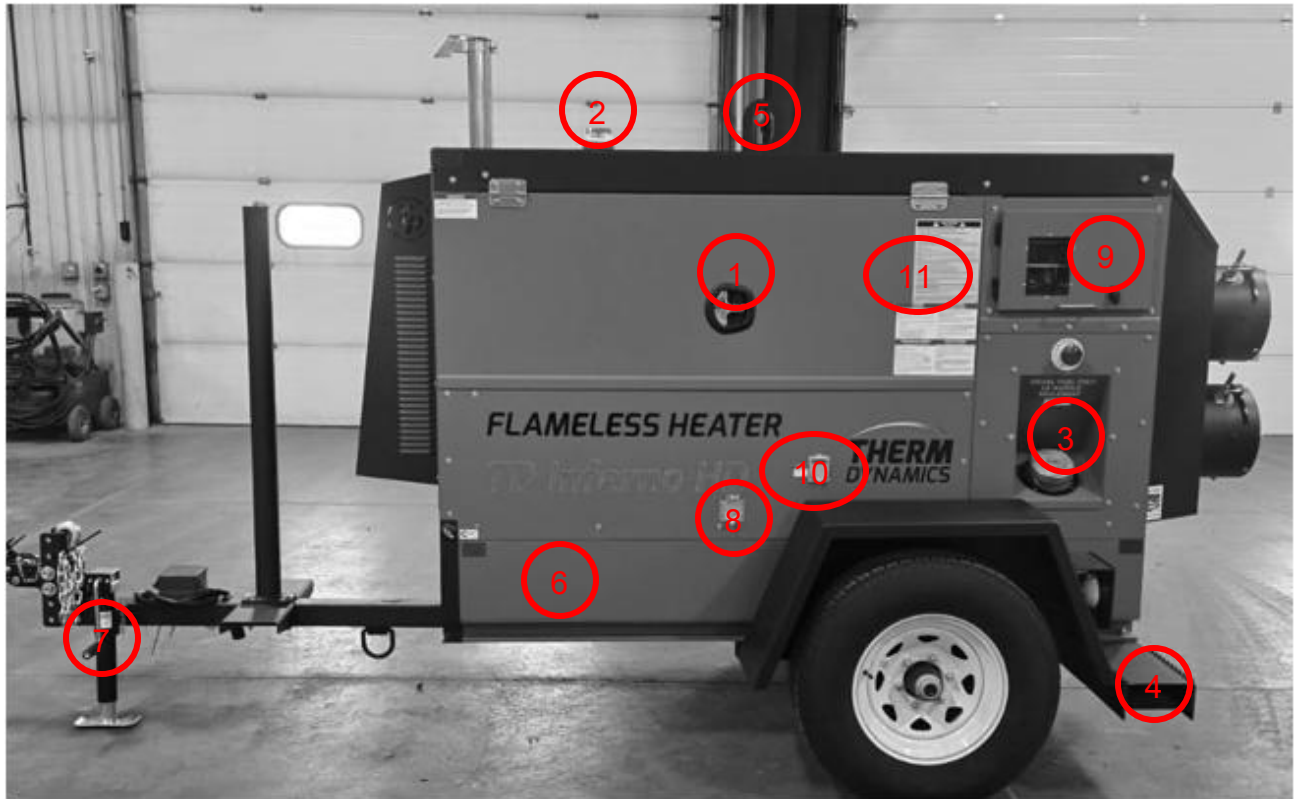

1. T-Handle Door Latch
2. Strobe Light
3. Fuel Fill (Outside Fill)
4. Fork Pocket
5. Skyhook
6. Fuel Tank
7. Trailer Jack
8. Access Port for Drain Hoses and Extension Cords
9. Control Panel Access
10. Remote Temp Probe Access
11. Warning and Caution Decals

Right Side Engine View

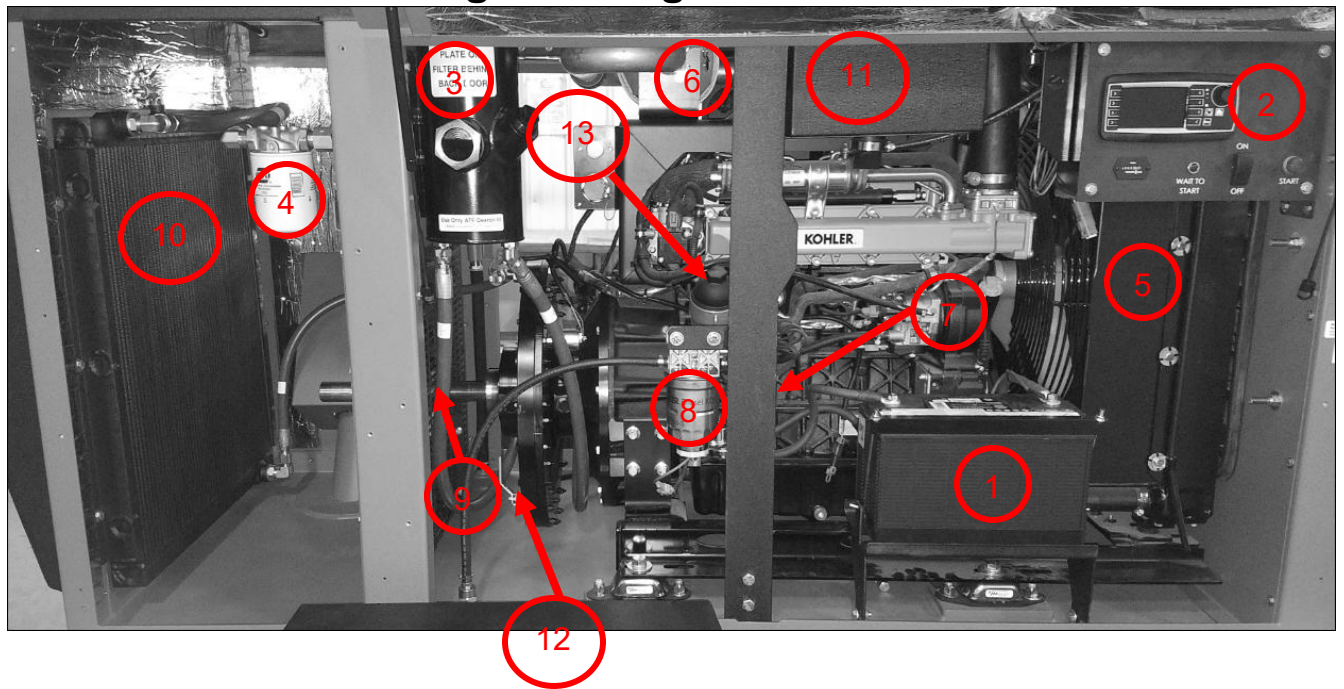

1. Battery
2. Control Panel
3. Plate Oil Reservoir Tank
4. Plate Oil Filter
5. Engine Radiator
6. Engine After Treatment
7. Master Switch – Located Behind Fuel Filter
8. Fuel Filter
9. Pusher Fan
10. Oil Cooler
11. Air Cleaner
12. Heat Plate Drain Valve
13. Engine Oil Filter

Left Side Engine View

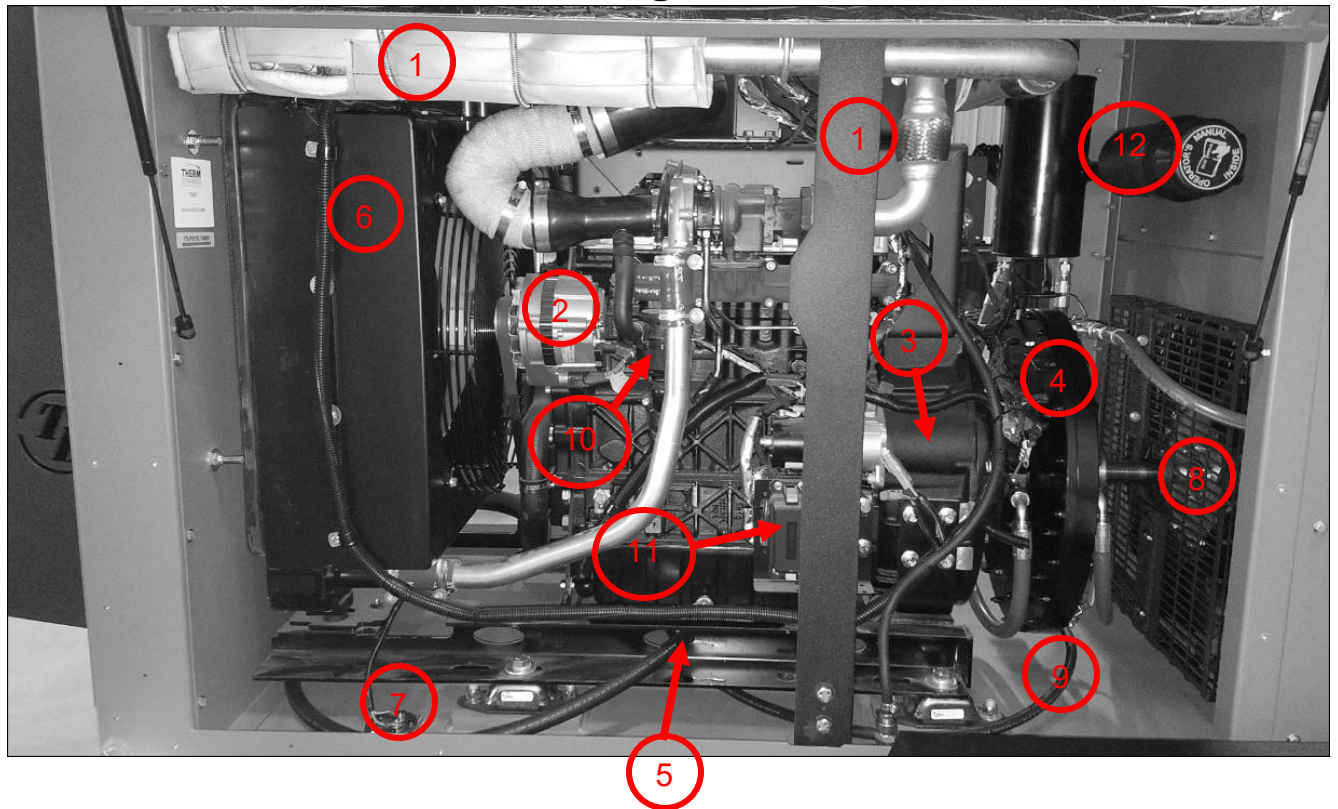

1. Exhaust
2. Alternator
3. Starter
4. Heat Plate
5. Engine Oil Drain Valve
6. Radiator
7. Fuel Sender
8. Pusher Fan
9. Plate Drain Hose
10. Crank Case Ventilation Module
11. Fuse Block
12. Owner's Manual

Front View

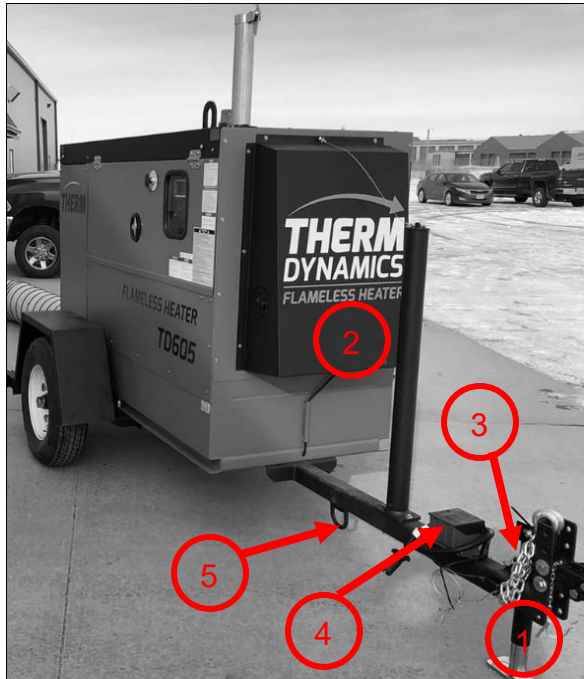

Rear View



1. Hand-Crank Jack
2. Air Intake
3. Safety Chains
4. Brake Away Box
5. D Ring for Tie Down

1. Air Outlet
2. Taillights (Blinkers and Brakes)
3. Fork Pocket
4. Clamps to Attach Hoses
5. Pressure Chamber Access Panel

Control Panel

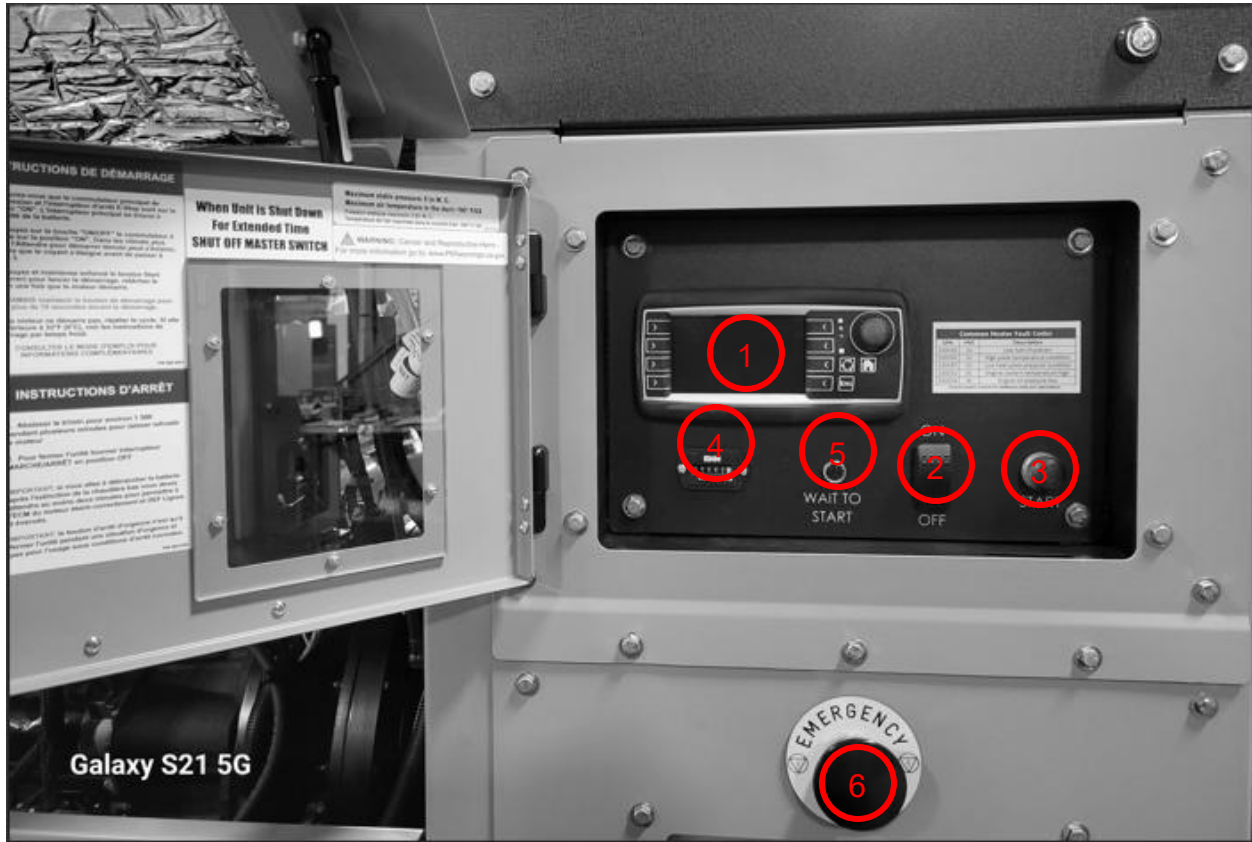

1. Controller Display
2. On/Off Switch
3. Start Button
4. Hour Meter
5. Glow Plug Light
6. Emergency Shut Off Button

PREPARING THE HEATER FOR OPERATION

The Therm Dynamics Heater requires service as well as proper operation in order to provide the performance and safety for which it was designed. Never deliver or put a machine into service with known defects or missing instructions or decals. Always instruct the customer in the proper operation and safety procedures as described in the operator's manual. Always provide the manual with the equipment for proper and safe operation.

Check List:

- Visually inspect the equipment to ensure that all instructions and decals are in place and legible.
- Check the hitch assembly and safety tow chains.
- Check the jack to make sure it operates properly.
- Inspect the tires to ensure good condition and proper inflation.
- Check lug nuts and torque to 80-90 ft. lbs. Lug nuts should be retorqued after first 100 miles of towing.
- Make sure the battery is fully charged and the terminals are tight and clean.
- Check the service intervals for oil filters, fuel filter, air cleaner and engine oil (see operator's manual).
- Before, during and after operations the entire unit should be checked for leaks. This includes the fuel lines and heat generation disk
- Check the oil, fuel and coolant levels.
- Verify that both 12" outlet tube openings are open and clear
- Check to make sure the operator's manual is with the equipment.

NOTE: See operator's manual for scheduled maintenance intervals.

In the event that problems or questions arise during the operation of this unit, feel free to call directly to the factory.

THERM DYNAMICS MFG. INC.
27077 S. Gayle Ave.
Tea, SD 57064
Phone: (605) 498-1050 – Fax: (605) 498-1051

STARTING PROCEDURES

BEFORE STARTING:

- Fill the engine with the specified grade and quantity of lubricating oil to correct level (check dipstick).
- Ensure there is an adequate supply of fuel.
- Ensure that the air cleaner is firmly attached and air joints are properly sealed. Air cleaner element should be checked and replaced if necessary.
- ATF Fluid should show in sight glass at all times in reservoir. Fluid should cover the entire sight glass at operating temps.
- All panels and doors must be in place and closed when the heating unit is in operation. Failure to do so could cause overheating of the oil and exhaust systems due to inadequate air flow.
- Verify the 12" duct tube outlets are open and not obstructed to allow air to flow freely

STARTING ENGINE

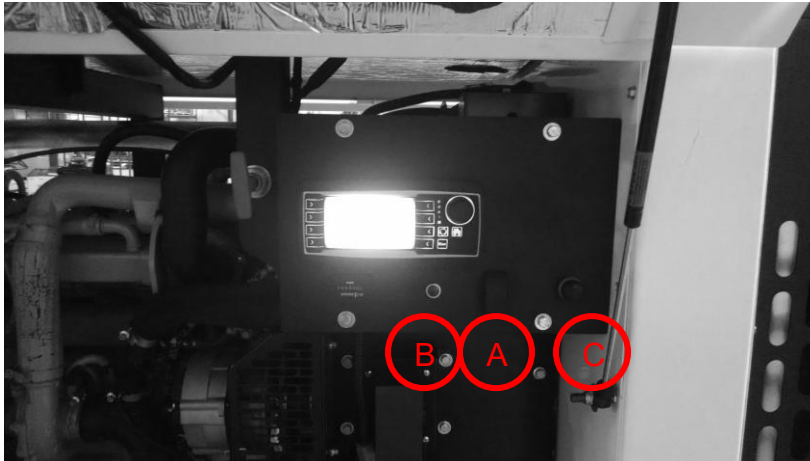

Note: Consult Control Panel Operation Guide prior to Operating Heater for the first time

- Turn on master power switch
- On the control panel turn the ON/OFF switch to the “ON” position (A)
- Wait to for glow plug light to shut off (B)
- Push the “START” button to engage the engine starter. (C)
- If the engine fails to start, repeat cycle.
- Maintain approximately 1500 RPM’s for several minutes allowing engine to warm up properly.

THROTTLE TEMPERATURE INTERLOCK

When the Throttle Temperature Interlock is Enabled, the Engine RPM will not be able to increase until the Engine Coolant Temperature reaches 120°F or 5 minutes of engine running has passed.

Once the interlock has been released, it will not become active again until the engine has stopped running.

If the throttle is currently interlocked, an icon will show on the Home screen next to the Engine Coolant Temperature.

SHUT DOWN PROCEDURES

- Lower the RPM to approximately 1,500 for several minutes to allow engine to cool down
- To shut the unit down turn ON/OFF switch to OFF position (A)
- **IMPORTANT: If you are going to disconnect the battery after shutting the heater down you must wait at least TWO MINUTES to allow the engine ECM properly shut down.**
IMPORTANT: Emergency stop button is only to shut the unit down during an emergency and not for use under normal shutdown conditions.

COLD WEATHER STARTING

- In below freezing weather, the external engine heater that is mounted on the unit should be plugged into a 120V electrical outlet for approximately 2.5 hours
- In sub-arctic weather below -20 degrees F, the unit should be preheated in a shop or other structure before operating. The external engine heater should also be plugged in.

USING THE REMOTE TEMPERATURE CONTROL THROTTLE

The heater is equipped with the ability to control the throttle of the engine via a remote thermostat.

To use this feature:

- Control panel must be configured for use with a remote throttle setup.
 - On the control screen, the hard key on the upper left of the display will need to be pressed to change between the auto and manual modes, select auto
 - (See Page 3 of **Therm Dynamics - Control Panel Operation manual**)
- End user must have the temperature probe (Included with Heater) plugged into the system via an extension cord in order to enable the automatic control. (figure 1)
- Below the engine rpm, there will now be two additional values indicated.
Act xx°F and SP xx°F
 - Act is referring to the actual measured temperature of the area the probe is in
 - SP is referring to the set point or desired temperature that is selected on the display.
- When in **auto mode**, the set point is adjustable by using the encoder knob while in the home screen. If in the control screen, the hard key next to the temperature set point will need to be pressed to highlight the value before the encoder knob can be used to adjust the value
- Engine will increase and decrease rpm to maintain an area temperature matching the set point temperature

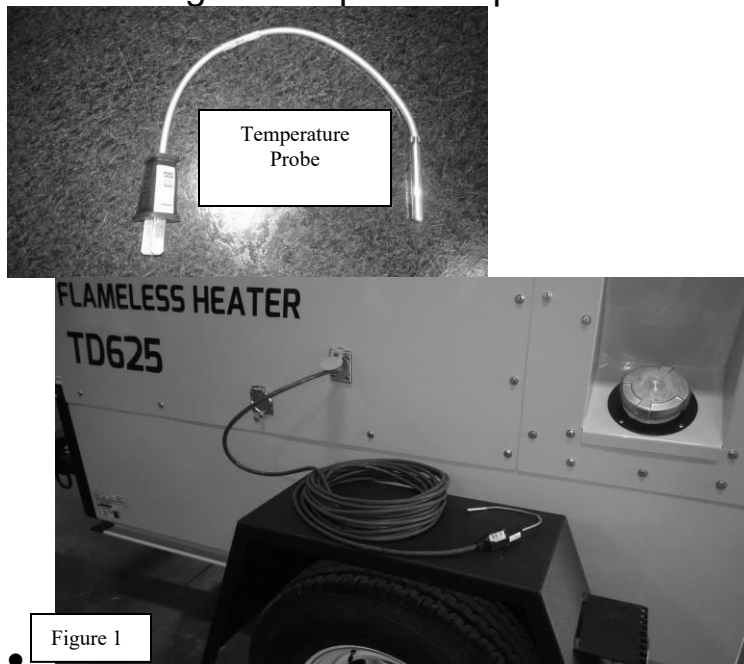

MAINTENANCE INSTRUCTIONS

- Do not tamper with unit. Have a competent serviceman make any adjustments
- Before removing any guards ensure all switches are in the off position
- Service intervals have been established for operation under normal conditions. Where equipment is operated under severe conditions (very dusty, extreme cold, etc.) affected items should be serviced more frequently
- ENGINE
 - Fuel Filter 500 hours
 - Oil Filter 500 hours
- Air Breather
 - Air Filter Annually, or as needed
- Hydraulic Filter 1,000 hours
- Radiator Coolant Check monthly
- Battery Bi-Annually, or as needed



- Battery gas is explosive
- Wear safety glasses and do not smoke while servicing battery
- When disconnecting or connecting the battery, always remove the negative(-) first and connect the negative (-) last to reduce arcing



TOWING INSTRUCTIONS

- Before towing the Therm Dynamics Heater, the trailer should be inspected visually to assure that the following operations have been completed:
- Hitch is securely attached to the towing vehicle (safety chain secured).
- Front jack retracted
- Ducting removed from heaters and stored
- Doors are closed and secure
- Check for adequate tire pressure
- Taillights are connected and operating.
- Verify the fuel tank is completely empty
- Towing hitch and hitch-ball are tight.
- Ensure that the Heater is level when hooked to the towing vehicle hitch. If not, adjust coupler on the heater to level the heater. If you

are unable to level the heater by adjusting the coupler, the hitch on the tow vehicle will need to be adjusted. Towing a heater that has not been leveled may cause towing difficulties such as swaying or vehicle squatting.

- Make sure couplers are locked/engaged and the safety pins are in place.
- Safety chains are properly attached and secure.
- If equipped with a Break Away box, attach engagement lanyard to tow vehicle.
- Check to ensure all lights on the heater are connected and working, ensure trailer wires are not touching the road, but loose enough to make turns without disconnecting or damaging the wires.
- It is recommended that the fuel tank is empty prior to towing. Although the fuel tanks are equipped with baffles, sloshing of fuel in the tank can still occur.
- Avoid crashes by slowing down. Reduce your speed from what you would normally drive without a trailer under similar road conditions. The recommended maximum speed is 55 mph when towing the Therm Dynamics Heater. Do not exceed any posted speed limit. Slow down for curves, adverse weather, hazardous road conditions, road construction, and expressway exits. Do not feel secure because your trailer tows easily at higher speeds.
- Persistent side to side sway motion is not normal. If this occurs at a certain speed, it is a signal that whipping will likely occur if speed is increased by a small amount. If you notice this behavior immediately slow down and maintain at least 10 mph below the speed swaying was first noticed. Then stop to check the trailer as soon as possible.



LIFTING INSTRUCTIONS

- Some heaters are equipped with a lifting eye. The lifting system on the Therm Dynamics heater is designed to pick the heater up in a static motion. (straight up and straight down)
- It is not recommended to use the lifting system to transport the heater. This is especially true when transporting over rough terrain as damage to the heater may occur.
- Although the lifting system is designed to lift the heater with fuel, it is recommended that the heater be lifted with an empty fuel tank to prevent inadvertent shifting of fuel when lifting the heater.

SPECIFICATIONS

MODEL	TD INFERNO
POWER PLANT	Kohler KDI 2504
FUEL	DIESEL #2
EST OUTPUT BTU	600,000
INPUT BTU MIN/MAX	138,000 / 144,000
EFFICIENCY	90%+
CFM	5,000+
TEMPERATURE	180°F+
MAX FUEL CONSUMPTION	4.3 gal/hr Est.
DIMENSIONS	
HEIGHT	92"
WIDTH	66"
LENGTH	156"
WEIGHT	
EMPTY Approx.	3,690
FULL Approx.	5,090
FUEL CAPACITY	118 or 200 GALS

AUTOMATIC SHUT-DOWN SYSTEM

This unit is equipped with automatic shut-down on any one of the following conditions:

- Low oil pressure (heat generating unit)
- Low oil pressure (engine)
- High water temperature (engine)
- High oil temperature (heat generating unit)
- This unit is also equipped with an engine over speed shut down valve designed to automatically stop the engine by closing down the air intake should excessive over speeding occur. It is also fitted with a Manual Shutdown Cable located inside the heat chamber.

LUBRICANTS

The lubricant inside the heat plate assembly is ATF Dexron III or Calflo AF, manufactured especially for hot and cold conditions in this type of application. It also has anti-corrosion and anti-foaming properties. The oil and the inline filter should be changed every 1,000 hours of operating time. DO NOT add or replace the oil in the heat generation unit with any other fluid as very adverse effects to bearing life and performance could occur (see manual supplied by engine manufacturer for engine lubrications and maintenance).

As a standard operating procedure, the engine oil needs to be checked **DAILY**. It is recommended that the daily oil level check is strictly adhered to. Also, oil changes should not exceed the **500 hour change interval**. Engine oil should be of appropriate API or ACEA classification. See below for additional information. Change the type of engine oil according to the ambient temperature.

VISCOSITY	SAE	15W-40 (-15°C ÷ +50°C) 10W-30 (-25°C ÷ +40°C) 10W-40 (-25°C ÷ +50°C) 5W-30 (-30°C ÷ +40°C) 0W-40 (-40°C ÷ +50°C)	
	TCR TIER IV FINAL		
WITH SPECIFICATIONS	API	CJ-4 Low S.A.P.S	
	ACEA	E9 Mid S.A.P.S.	
		E6 Low S.A.P.S.	

TELEMATICS - GLOBAL POSITION SYSTEM (GPS)

This unit is equipped with an auxiliary connector to aid in the installation telematics system. The connection provides 12+VDC, Ground, Keyswitch Power & Engine Run Signal.

NOTE: Connecting to other system wiring other than the provided auxiliary connector can lead to significant electrical issues and voids your heater's warranty.

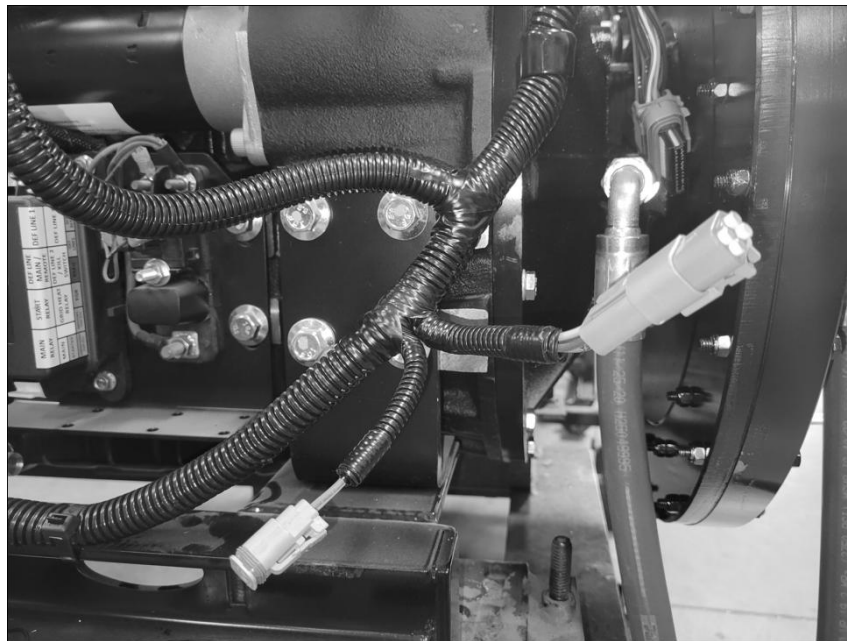
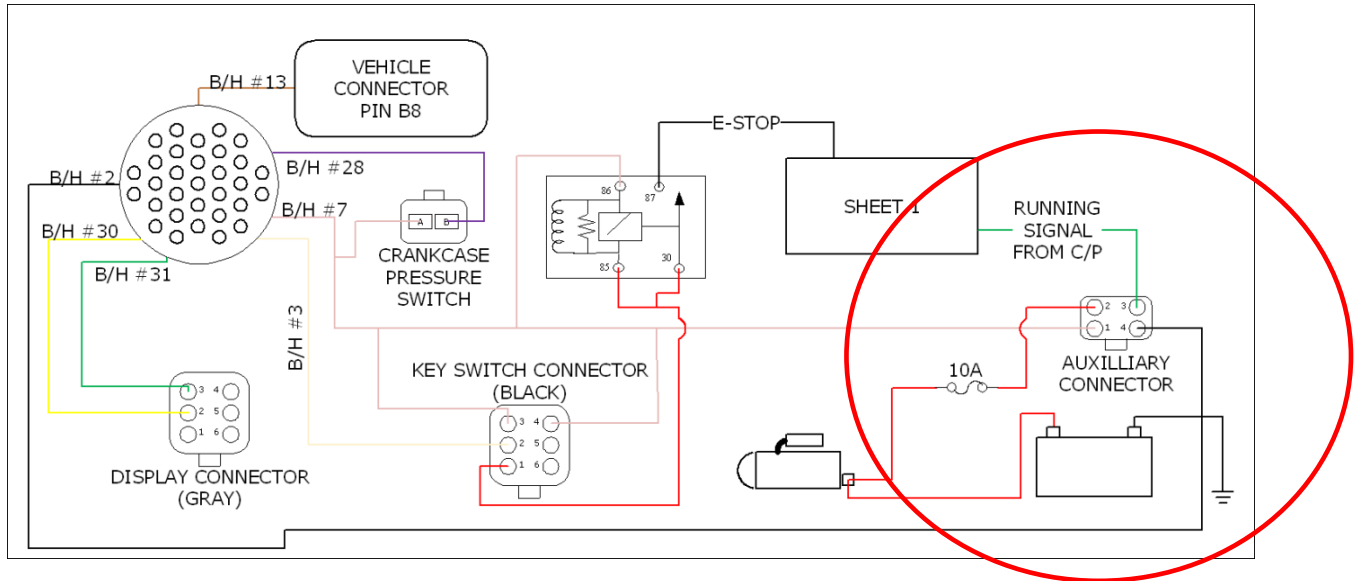

TROUBLE SHOOTING GUIDE

PROBLEM	POSSIBLE CAUSE	SOLUTION
The Engine will not crank	The Master Switch is not ON	Open up the main door on the left side and locate the Master Switch on the left front end of the engine. Turn counter clockwise to a 45 degree angle
	Battery is Dead	Charge the battery, Clean the terminals
The Engine will Crank but not Start	Out of Fuel	Check the Fuel Gauge and verify there is fuel in the tank
	Chalwyn Valve Activated	Wait a couple of minutes for the valve to reset itself, if desired, the turbo side hose can be loosened temporarily to speed up the process
	Air in the Fuel System	Crack the fuel lines on top of the injectors and prime system until there is no air coming out, then retighten the fitting.
	Fuel Injection Pump not primed	Turn the power switch on and off to engage the primer pump.
The unit is overheating and shutting down	All or some of the doors are not closed	Verify all of the doors are sealed tight so that all of the air in the heat chamber is exited out through the outlet
	Outlets are not open	Verify that both the 12" outlets or the flexible hoses have nothing obstructing the openings
	Front radiator package or rear oil cooler are full of debris	Periodically inspect and pressure wash to clear all debris
	The Engine RPM is set too high based on the ambient temperature	The Heat Plate Temperature gauge is set to shutdown if the plates reach around 250 degrees. If the louvers are wide open and the unit is shutting down, lower the RPM
	Front Louvers are not Open	The Louver Rod has become disconnected from the Upper Louver Arm. Reattach the rod through the swivel bolts
		Open Louvers by putting the arm in the horizontal position
The Heat Plate Oil Pressure Gauge shows no, or little Pressure	There is no Hydraulic Oil in the Heat Plate System	Check the Hydraulic Oil Reservoir to verify that there is Oil visible in the site glass. If not, add the same Oil that is noted on the reservoir
	The Oil Pressure Gauge is not working	Replace the Gauge

TIRE SAFETY INFORMATION

This portion of the User's Manual contains tire safety information as required by 79 CFR 575.6

Section 1.1 contains "Steps for Determining Correct Load Limit – Trailer".

Section 1.2 contains "Steps for Determining Correct Load Limit – Tow Vehicle".

Section 1.3 contains a Glossary of Tire Terminology, including "cold inflation pressure", "maximum inflation pressure", "recommended inflation pressure", and other non technical terms.

Section 1.4 contains information from the NHTSA brochure entitled "Tire Safety - Everything Rides On It". This brochure, as well as the preceding subsections, describes the following items;

Tire labeling, including a description and explanation of each marking on the tires, and information about the DOT Tire Identification Number (TIN).

Recommended tire inflation pressure, including a description and explanation of:

- A. Cold inflation pressure.
- B. Vehicle Placard and location on the vehicle.
- C. Adverse safety consequences of under inflation (including tire failure).
- D. Measuring and adjusting air pressure for proper inflation.

Tire Care, including maintenance and safety practices.

Vehicle load limits, including a description and explanation of the following items:

- A. Locating and understanding the load limit information, total load capacity, and cargo capacity.
- B. Calculating total and cargo capacities with varying seating configurations including quantitative examples showing / illustrating how the vehicles cargo and luggage capacity decreases as combined number and size of occupants' increases. This item is also discussed in Section 3.
- C. Determining compatibility of tire and vehicle load capabilities.
- D. Adverse safety consequences of overloading on handling and stopping on tires.

1.1. STEPS FOR DETERMINING CORRECT LOAD LIMIT - TRAILER

Determining the load limits of a trailer includes more than understanding the load limits of the tires alone. On all trailers there is a Federal certification/VIN label that is located on the forward half of the left (road) side of the unit. This certification/VIN label will indicate the trailer's Gross Vehicle Weight Rating (GVWR). This is the most weight the fully loaded trailer can weigh. It will also provide the Gross Axle Weight Rating (GAWR). This is the most a particular axle can weigh. If there are multiple axles, the GAWR of each axle will be provided.

If your trailer has a GVWR of 10,000 pounds or less, there is a vehicle placard located in the same location as the certification label described above. This placard provides tire and loading information. In addition, this placard will show a statement regarding maximum cargo capacity. Cargo can be added to the trailer, up to the maximum weight specified on the placard. The combined weight of the cargo is provided as a single number. In any case, remember: the total weight of a fully loaded trailer can not exceed the stated GVWR.

For trailers with living quarters installed, the weight of water and propane also need to be considered. The weight of fully filled propane containers is considered part of the weight of the trailer before it is loaded with cargo, and is not considered part of the disposable cargo load. Water however, is a disposable cargo weight and is treated as such. If there is a fresh water storage tank of 100 gallons, this tank when filled would weigh about 800 pounds. If more cargo is being transported, water can be off-loaded to keep the total amount of cargo added to the vehicle within the limits of the GVWR so as not to overload the vehicle. Understanding this flexibility will allow you, the owner, to make choices that fit your travel needs.

When loading your cargo, be sure it is distributed evenly to prevent overloading front to back and side to side. Heavy items should be placed low and as close to the axle positions as reasonable. Too many items on one side may overload a tire. The best way to know the actual weight of the vehicle is to weigh it at a public scale. Talk to your dealer to discuss the weighing methods needed to capture the various weights related to the trailer. This would include the weight empty or unloaded, weights per axle, wheel, hitch or king-pin, and total weight.

Excessive loads and/or underinflation cause tire overloading and, as a result, abnormal tire flexing occurs. This situation can generate an excessive amount of heat within the tire. Excessive heat may lead to tire failure. It is the air pressure that enables a tire to support the load, so proper inflation is critical. The proper air pressure may be found on the certification/VIN label and/or on the Tire Placard. This value should never exceed the maximum cold inflation pressure stamped on the tire.

1.1.1. TRAILERS 10,000 POUNDS GVWR OR LESS

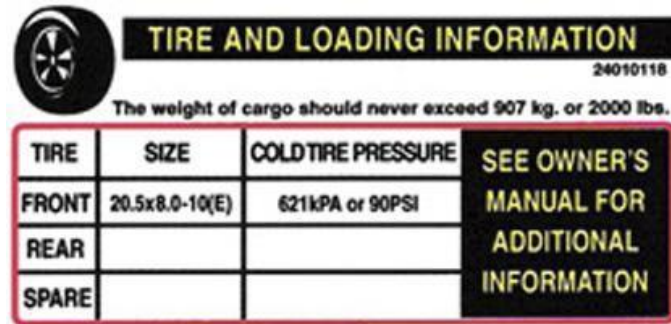

Tire and Loading Information Placard = Figure 1-1

1. Locate the statement, "The weight of cargo should never exceed XXX kg or XXX lbs.," on your vehicle's placard. See figure 1-1.
2. This figure equals the available amount of cargo and luggage load capacity.
3. Determine the combined weight of luggage and cargo being loaded on the vehicle. That weight may not safely exceed the available cargo and luggage load capacity.

The Trailer's placard refers to the Tire Information Placard attached adjacent to or near the trailer's VIN (Certification) label at the left front of the trailer.

1.1.2. TRAILERS OVER 10,000 POUNDS GVWR (NOTE: THESE TRAILERS ARE NOT REQUIRED TO HAVE A TIRE INFORMATION PLACARD ON THE VEHICLE)

1. Determine the empty weight of your trailer by weighing the trailer using a public scale or other means. This step does not have to be repeated.
2. Locate the GVWR (Gross Vehicle Weight Rating" of the trailer on your trailer's VIN (Certification) label.
3. Subtract the empty weight of your trailer from the GVWR stated on the VIN label. That weight is the maximum available cargo capacity of the trailer and may not be safely exceeded.

1.2. STEPS FOR DETERMINING CORRECT LOAD LIMIT - TOW VEHICLE

1. Locate the statement, "The combined weight of occupants and cargo should never exceed XXX lbs.," on your vehicle's placard.
2. Determine the combined weight of the driver and passengers who will be riding in your vehicle.
3. Subtract the combined weight of the driver and passengers from XXX kilograms or XXX pounds.
4. The resulting figure equals the available amount of cargo and luggage capacity. For example, if the "XXX" amount equals 1400 lbs. and there will be five 150 lb. passengers in your vehicle, the amount of available cargo and luggage capacity is 650 lbs. (1400-750 (5 x 150) = 650 lbs.).
5. Determine the combined weight of luggage and cargo being loaded on the vehicle. That weight may not safely exceed the available cargo and luggage capacity calculated in Step # 4.
6. If your vehicle will be towing a trailer, load from your trailer will be transferred to your vehicle. Consult the tow vehicle's manual to determine how this weight transfer reduces the available cargo and luggage capacity of your vehicle.

1.3. GLOSSARY OF TIRE TERMINOLOGY

Accessory weight

The combined weight (in excess of those standard items which may be replaced) of automatic transmission, power steering, power brakes, power windows, power seats, radio and heater, to the extent that these items are available as factory-installed equipment (whether installed or not).

Bead

The part of the tire that is made of steel wires, wrapped or reinforced by ply cords and that is shaped to fit the rim.

Bead separation

This is the breakdown of the bond between components in the bead.

Bias ply tire

A pneumatic tire in which the ply cords that extend to the beads are laid at alternate angles substantially less than 90 degrees to the centerline of the tread.

Carcass

The tire structure, except tread and sidewall rubber which, when inflated, bears the load.

Chunking

The breaking away of pieces of the tread or sidewall.

Cold inflation pressure

The pressure in the tire before you drive.

Cord

The strands forming the plies in the tire.

Cord separation

The parting of cords from adjacent rubber compounds.

Cracking

Any parting within the tread, sidewall, or inner liner of the tire extending to cord material.

CT

A pneumatic tire with an inverted flange tire and rim system in which the rim is designed with rim flanges pointed radially inward and the tire is designed to fit on the underside of the rim in a manner that encloses the rim flanges inside the air cavity of the tire.

Curb weight

The weight of a motor vehicle with standard equipment including the maximum capacity of fuel, oil, and coolant, and, if so equipped, air conditioning and additional weight optional engine.

Extra load tire

A tire designed to operate at higher loads and at higher inflation pressures than the corresponding standard tire.

Groove

The space between two adjacent tread ribs.

Gross Axle Weight Rating

The maximum weight that any axle can support, as published on the Certification / VIN label on the front left side of the trailer. Actual weight determined by weighing each axle on a public scale, with the trailer attached to the towing vehicle.

Gross Vehicle Weight Rating

The maximum weight of the fully loaded trailer, as published on the Certification / VIN label. Actual weight determined by weighing trailer on a public scale, without being attached to the towing vehicle.

Hitch Weight

The downward force exerted on the hitch ball by the trailer coupler.

Innerliner

The layer(s) forming the inside surface of a tubeless tire that contains the inflating medium within the tire.

Innerliner separation

The parting of the innerliner from cord material in the carcass.

Intended outboard sidewall

The sidewall that contains a white-wall, bears white lettering or bears manufacturer, brand, and/or model name molding that is higher or deeper than the same molding on the other sidewall of the tire or the outward facing sidewall of an asymmetrical tire that has a particular side that must always face outward when mounted on a vehicle.

Light truck (LT) tire

A tire designated by its manufacturer as primarily intended for use on lightweight trucks or multipurpose passenger vehicles.

Load rating

The maximum load that a tire is rated to carry for a given inflation pressure.

Maximum load rating

The load rating for a tire at the maximum permissible inflation pressure for that tire.

Maximum permissible inflation pressure

The maximum cold inflation pressure to which a tire may be inflated.

Maximum loaded vehicle weight

The sum of curb weight, accessory weight, vehicle capacity weight, and production options weight.

Measuring rim

The rim on which a tire is fitted for physical dimension requirements.

Pin Weight

The downward force applied to the 5th wheel or gooseneck ball, by the trailer kingpin or gooseneck coupler.

Non-pneumatic rim

A mechanical device which, when a non-pneumatic tire assembly incorporates a wheel, supports the tire, and attaches, either integrally or separably, to the wheel center member and upon which the tire is attached.

Non-pneumatic spare tire assembly

A non-pneumatic tire assembly intended for temporary use in place of one of the pneumatic tires and rims that are fitted to a passenger car in compliance with the requirements of this standard.

Non-pneumatic tire

A mechanical device which transmits, either directly or through a wheel or wheel center member, the vertical load and tractive forces from the roadway to the vehicle, generates the tractive forces that provide the directional control of the vehicle and does not rely on the containment of any gas or fluid for providing those functions.

Non-pneumatic tire assembly

A non-pneumatic tire, alone or in combination with a wheel or wheel center member, which can be mounted on a vehicle.

Normal occupant weight

This means 68 kilograms (150 lbs.) times the number of occupants specified in the second column of Table I of 49 CFR 571.110.

Occupant distribution

The distribution of occupants in a vehicle as specified in the third column of Table I of 49 CFR 571.110.

Open splice

Any parting at any junction of tread, sidewall, or innerliner that extends to cord material.

Outer diameter

The overall diameter of an inflated new tire.

Overall width

The linear distance between the exteriors of the sidewalls of an inflated tire, including elevations due to labeling, decorations, or protective bands or ribs.

Ply

A layer of rubber-coated parallel cords.

Ply separation

A parting of rubber compound between adjacent plies.

Pneumatic tire

A mechanical device made of rubber, chemicals, fabric and steel or other materials, that, when mounted on an automotive wheel, provides the traction and contains the gas or fluid that sustains the load.

Production options weight

The combined weight of those installed regular production options weighing over 2.3 kilograms (5 lbs.) in excess of those standard items which they replace, not previously considered in curb weight or accessory weight, including heavy duty brakes, ride levelers, roof rack, heavy duty battery, and special trim.

Radial ply tire

A pneumatic tire in which the ply cords that extend to the beads are laid at substantially 90 degrees to the centerline of the tread.

Recommended inflation pressure

This is the inflation pressure provided by the vehicle manufacturer on the Tire Information label and on the Certification / VIN tag.

Reinforced tire

A tire designed to operate at higher loads and at higher inflation pressures than the corresponding standard tire.

Rim

A metal support for a tire or a tire and tube assembly upon which the tire beads are seated.

Rim diameter

This means the nominal diameter of the bead seat.

Rim size designation

This means the rim diameter and width.

Rim type designation

This means the industry of manufacturer's designation for a rim by style or code.

Rim width

This means the nominal distance between rim flanges.

Section width

The linear distance between the exteriors of the sidewalls of an inflated tire, excluding elevations due to labeling, decoration, or protective bands.

Sidewall

That portion of a tire between the tread and bead.

Sidewall separation

The parting of the rubber compound from the cord material in the sidewall.

Special Trailer (ST) tire

The "ST" is an indication the tire is for trailer use only.

Test rim

The rim on which a tire is fitted for testing, and may be any rim listed as appropriate for use with that tire.

Tread

That portion of a tire that comes into contact with the road.

Tread rib

A tread section running circumferentially around a tire.

Tread separation

Pulling away of the tread from the tire carcass.

Treadwear indicators (TWI)

The projections within the principal grooves designed to give a visual indication of the degrees of wear of the tread.

Vehicle capacity weight

The rated cargo and luggage load plus 68 kilograms (150lbs) time the vehicle's designated seating capacity.

Vehicle maximum load on the tire

The load on an individual tire that is determined by distributing to each axle its share of the maximum loaded vehicle weight and dividing by two.

Vehicle normal load on the tire

The load on an individual tire that is determined by distributing to each axle its share of the curb weight, accessory weight, and normal occupant weight (distributed in accordance with Table I of CRF 49 571.110) and dividing by 2.

Weather side

The surface area of the rim not covered by the inflated tire.

Wheel center member

In the case of a non-pneumatic tire assembly incorporating a wheel, a mechanical device which attaches, either integrally or separably, to the non-pneumatic rim and provides the connection between the non-pneumatic rim and the vehicle; or, in the case of a non-pneumatic tire assembly not incorporating a wheel, a mechanical device which attaches, either integrally or separably, to the non-pneumatic tire and provides the connection between tire and the vehicle.

Wheel-holding fixture

The fixture used to hold the wheel and tire assembly securely during testing.

1.4. TIRE SAFETY - EVERYTHING RIDES ON IT

The National Traffic Safety Administration (NHTSA) has published a brochure (DOT HS 809 361) that discusses all aspects of Tire Safety, as required by CFR 575.6. This brochure is reproduced in part below. It can be obtained and downloaded from NHTSA, free of charge, from the following web site:

http://www.nhtsa.dot.gov/cars/rules/TireSafety/ridesonit/tires_index.html

Studies of tire safety show that maintaining proper tire pressure, observing tire and vehicle load limits (not carrying more weight in your vehicle than your tires or vehicle can safely handle), avoiding road hazards, and inspecting tires for cuts, slashes, and other irregularities are the most important things you can do to avoid tire failure, such as tread separation or blowout and flat tires. These actions, along with other care and maintenance activities, can also:

- Improve vehicle handling
- Help protect you and others from avoidable breakdowns and accidents
- Improve fuel economy
- Increase the life of your tires.

This booklet presents a comprehensive overview of tire safety, including information on the following topics:

- Basic tire maintenance
- Uniform Tire Quality Grading System
- Fundamental characteristics of tires

Use this information to make tire safety a regular part of your vehicle maintenance routine. Recognize that the time you spend is minimal compared with the inconvenience and safety consequences of a flat tire or other tire failure.

1.5. SAFETY FIRST-BASIC TIRE MAINTENANCE

Properly maintained tires improve the steering, stopping, traction, and load-carrying capability of your vehicle. Underinflated tires and overloaded vehicles are a major cause of tire failure. Therefore, as mentioned above, to avoid flat tires and other types of tire failure, you should maintain proper tire pressure, observe tire and vehicle load limits, avoid road hazards, and regularly inspect your tires.

1.5.1. FINDING YOUR VEHICLE'S RECOMMENDED TIRE PRESSURE AND LOAD LIMITS

Tire information placards and vehicle certification labels contain information on tires and load limits. These labels indicate the vehicle manufacturer's information including:

- Recommended tire size
- Recommended tire inflation pressure
- Vehicle capacity weight (VCW-the maximum occupant and cargo weight a vehicle is designed to carry)
- Front and rear gross axle weight ratings (GAWR-the maximum weight the axle systems are designed to carry).

Both placards and certification labels are permanently attached to the trailer near the left front.

1.5.2. UNDERSTANDING TIRE PRESSURE AND LOAD LIMITS

Tire inflation pressure is the level of air in the tire that provides it with load-carrying capacity and affects the overall performance of the vehicle. The tire inflation pressure is a number that indicates the amount of air pressure± measured in pounds per square inch (psi)-a tire requires to be properly inflated. (You will also find this number on the vehicle information placard expressed in kilopascals (kpa), which is the metric measure used internationally.)

Manufacturers of passenger vehicles and light trucks determine this number based on the vehicle's design load limit, that is, the greatest amount of weight a vehicle can safely carry and the vehicle's tire size. The proper tire pressure for your vehicle is referred to as the "recommended cold inflation pressure." (As you will read below, it is difficult to obtain the recommended tire pressure if your tires are not cold.) Because tires are designed to be used on more than one type of vehicle, tire manufacturers list the "maximum permissible inflation pressure" on the tire sidewall. This number is the greatest amount of air pressure that should ever be put in the tire under normal driving conditions.

1.5.3. CHECKING TIRE PRESSURE

It is important to check your vehicle's tire pressure at least once a month for the following reasons:

- Most tires may naturally lose air over time.
- Tires can lose air suddenly if you drive over a pothole or other object or if you strike the curb when parking.
- With radial tires, it is usually not possible to determine underinflation by visual inspection.

For convenience, purchase a tire pressure gauge to keep in your vehicle. Gauges can be purchased at tire dealerships, auto supply stores, and other retail outlets. The recommended tire inflation pressure that vehicle manufacturers provide reflects the proper psi when a tire is cold. The term cold does not relate to the outside temperature. Rather, a cold tire is one that has not been driven on for at least three hours. When you drive, your tires get warmer, causing the air pressure within them to increase. Therefore, to get an accurate tire pressure reading, you must measure tire pressure when the tires are cold or compensate for the extra pressure in warm tires.

1.5.4. STEPS FOR MAINTAINING PROPER TIRE PRESSURE

- Step 1: Locate the recommended tire pressure on the vehicle's tire information placard, certification label, or in the owner's manual.
- Step 2: Record the tire pressure of all tires.
- Step 3: If the tire pressure is too high in any of the tires, slowly release air by gently pressing on the tire valve stem with the edge of your tire gauge until you get to the correct pressure.
- Step 4: If the tire pressure is too low, note the difference between the measured tire pressure and the correct tire pressure. These "missing" pounds of pressure are what you will need to add.
- Step 5: At a service station, add the missing pounds of air pressure to each tire that is underinflated.
- Step 6: Check all the tires to make sure they have the same air pressure (except in cases in which the front and rear tires are supposed to have different amounts of pressure).

If you have been driving your vehicle and think that a tire is underinflated, fill it to the recommended cold inflation pressure indicated on your vehicle's tire information placard or certification label. While your tire may still be slightly underinflated due to the extra pounds of pressure in the warm tire, it is safer to drive with air pressure that is slightly lower than the vehicle manufacturer's recommended cold inflation pressure than to drive with a significantly underinflated tire. Since this is a temporary fix, don't forget to recheck and adjust the tire's pressure when you can obtain a cold reading.

1.5.5. TIRE SIZE

To maintain tire safety, purchase new tires that are the same size as the vehicle's original tires or another size recommended by the manufacturer. Look at the tire information placard, the owner's manual, or the sidewall of the tire you are replacing to find this information. If you have any doubt about the correct size to choose, consult with the tire dealer.

1.5.6. TIRE TREAD

The tire tread provides the gripping action and traction that prevent your vehicle from slipping or sliding, especially when the road is wet or icy. In general, tires are not safe and should be replaced when the tread is worn down to 1/16 of an inch. Tires have built-in treadwear indicators that let you know when it is time to replace your tires. These indicators are raised sections spaced intermittently in the bottom of the tread grooves. When they appear "even" with the outside of the tread, it is time to replace your tires. Another method for checking tread depth is to place a penny in the tread with Lincoln's head upside down and facing you. If you can see the top of Lincoln's head, you are ready for new tires.

1.5.7. TIRE BALANCE AND WHEEL ALIGNMENT

To avoid vibration or shaking of the vehicle when a tire rotates, the tire must be properly balanced. This balance is achieved by positioning weights on the wheel to counterbalance heavy spots on the wheel-and-tire assembly. A wheel alignment adjusts the angles of the wheels so that they are positioned correctly relative to the vehicle's frame. This adjustment maximizes the life of your tires. These adjustments require special equipment and should be performed by a qualified technician.

1.5.8. TIRE REPAIR

The proper repair of a punctured tire requires a plug for the hole and a patch for the area inside the tire that surrounds the puncture hole. Punctures through the tread can be repaired if they are not too large, but punctures to the sidewall should not be repaired. Tires must be removed from the rim to be properly inspected before being plugged and patched.

1.5.9. TIRE FUNDAMENTALS

Federal law requires tire manufacturers to place standardized information on the sidewall of all tires. This information identifies and describes the fundamental characteristics of the tire and also provides a tire identification number for safety standard certification and in case of a recall.

1.5.9.1. Information on Passenger Vehicle Tires

Please refer to the diagram below.

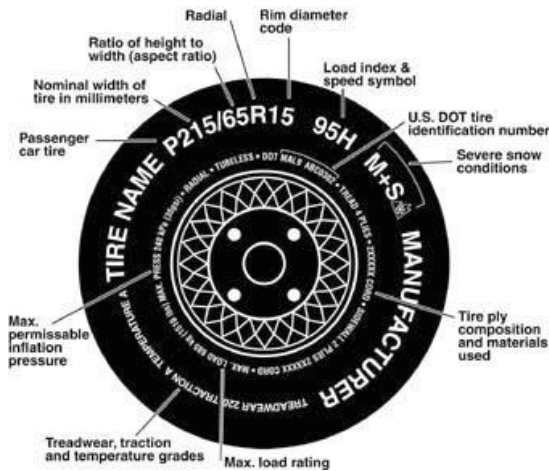

P

The "P" indicates the tire is for passenger vehicles.

Next number

This three-digit number gives the width in millimeters of the tire from sidewall edge to sidewall edge. In general, the larger the number, the wider the tire.

Next number

This two-digit number, known as the aspect ratio, gives the tire's ratio of height to width. Numbers of 70 or lower indicate a short sidewall for improved steering response and better overall handling on dry pavement.

R

The "R" stands for radial. Radial ply construction of tires has been the industry standard for the past 20 years.

Next number

This two-digit number is the wheel or rim diameter in inches. If you change your wheel size, you will have to purchase new tires to match the new wheel diameter.

Next number

This two- or three-digit number is the tire's load index. It is a measurement of how much weight each tire can support. You may find this information in your owner's manual. If not, contact a local tire dealer. Note: You may not find this information on all tires because it is not required by law.

M+S

The "M+S" or "M/S" indicates that the tire has some mud and snow capability. Most radial tires have these markings; hence, they have some mud and snow capability.

Speed Rating

The speed rating denotes the speed at which a tire is designed to be driven for extended periods of time. The ratings range from 99 miles per hour (mph) to 186 mph. These ratings are listed below. Note: You may not find this information on all tires because it is not required by law.

Letter Rating	Speed Rating
Q	99 mph
R	106 mph
S	112 mph
T	118 mph
U	124 mph
H	130 mph
V	149 mph
W	168* mph
Y	186* mph

* For tires with a maximum speed capability over 149 mph, tire manufacturers sometimes use the letters ZR. For those with a maximum speed capability over 186 mph, tire manufacturers always use the letters ZR.

U.S. DOT Tire Identification Number

This begins with the letters "DOT" and indicates that the tire meets all federal standards. The next two numbers or letters are the plant code where it was manufactured, and the last four numbers represent the week and year the tire was built. For example, the numbers 3197 means the 31st week of 1997. The other numbers are marketing codes used at the manufacturer's discretion. This information is used to contact consumers if a tire defect requires a recall.

Tire Ply Composition and Materials Used

The number of plies indicates the number of layers of rubber-coated fabric in the tire. In general, the greater the number of plies, the more weight a tire can support. Tire manufacturers also must indicate the materials in the tire, which include steel, nylon, polyester, and others.

Maximum Load Rating

This number indicates the maximum load in kilograms and pounds that can be carried by the tire.

Maximum Permissible Inflation Pressure

This number is the greatest amount of air pressure that should ever be put in the tire under normal driving conditions.

1.5.9.2. UTQGS Information

Treadwear Number

This number indicates the tire's wear rate. The higher the treadwear number is, the longer it should take for the tread to wear down. For example, a tire graded 400 should last twice as long as a tire graded 200.

Traction Letter

This letter indicates a tire's ability to stop on wet pavement. A higher graded tire should allow you to stop your car on wet roads in a shorter distance than a tire with a lower grade. Traction is graded from highest to lowest as "AA", "A", "B", and "C".

Temperature Letter

This letter indicates a tire's resistance to heat. The temperature grade is for a tire that is inflated properly and not overloaded. Excessive speed, underinflation or excessive loading, either separately or in combination, can cause heat build-up and possible tire failure. From highest to lowest, a tire's resistance to heat is graded as "A", "B", or "C".

Please refer to the following diagram.

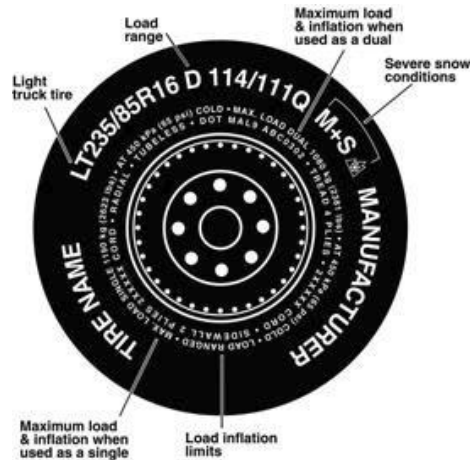

Tires for light trucks have other markings besides those found on the sidewalls of passenger tires.

LT

The "LT" indicates the tire is for light trucks or trailers.

ST

An "ST" is an indication the tire is for trailer use only.

Max. Load Dual kg (lbs) at kPa (psi) Cold

This information indicates the maximum load and tire pressure when the tire is used as a dual, that is, when four tires are put on each rear axle (a total of six or more tires on the vehicle).

Max. Load Single kg (lbs) at kPa (psi) Cold

This information indicates the maximum load and tire pressure when the tire is used as a single.

Load Range

This information identifies the tire's load-carrying capabilities and its inflation limits.

1.6. TIRE SAFETY TIPS

Preventing Tire Damage

- Slow down if you have to go over a pothole or other object in the road.
- Do not run over curbs or other foreign objects in the roadway, and try not to strike the curb when parking.

Tire Safety Checklist

- Check tire pressure regularly (at least once a month), including the spare.
- Inspect tires for uneven wear patterns on the tread, cracks, foreign objects, or other signs of wear or trauma.
- Remove bits of glass and foreign objects wedged in the tread.
- Make sure your tire valves have valve caps.
- Check tire pressure before going on a long trip.
- Do not overload your vehicle. Check the Tire Information and Loading Placard or User's Manual for the maximum recommended load for the vehicle.

Reporting Safety Defects

If you believe your trailer has a defect which could cause a crash or could cause injury or death, you should immediately inform the National Highway Traffic Safety Administration (NHTSA) in addition to notifying Therm Dynamics.

If NHTSA receives similar complaints, it may open an investigation; and if it finds that a safety defect exists in a group of trailers, it may order a recall and remedy campaign. However, NHTSA cannot become involved in individual problems between you, your dealer, or Therm Dynamics.

To contact NHTSA, you may either contact the Vehicle Safety Hotline toll-free at 1-888-327-4236 (TTY: 1-800-424-9153); go to <http://www.safercar.gov>; or write to:

Administrator
NHTSA
1200 New Jersey Avenue S.E. Washington, DC 20590

You can also obtain other information about your motor vehicle safety from <http://www.safercar.gov>